

ASSEMBLY INSTRUCTIONS

Vivienne
OFFICE CHAIR
ITEM CODE:69396

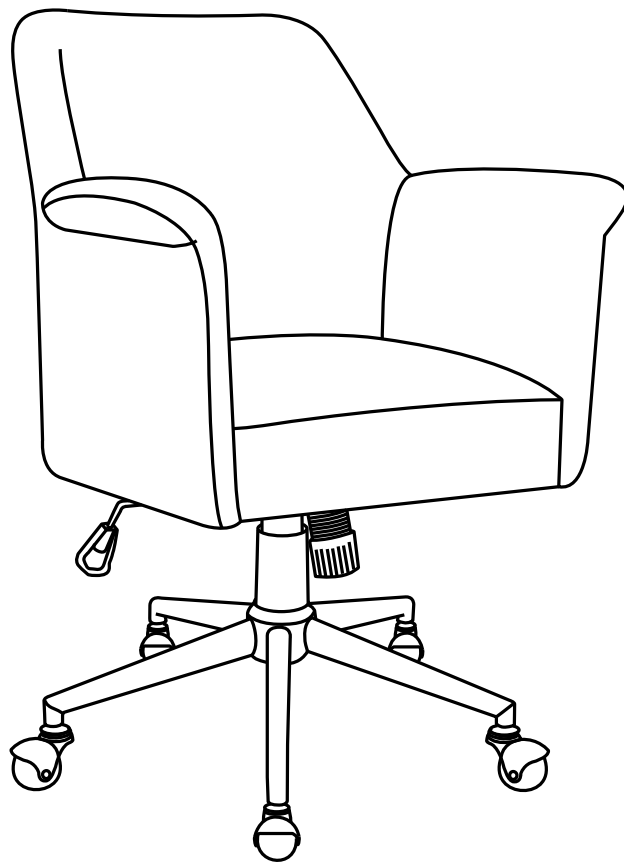



Imported by JWA Furniture Pty Ltd, Qld, Brisbane Australia.
For any assistance with assembly or for missing parts please refer to your receipt

PRE-ASSEMBLY PREPARATION

Before you start:

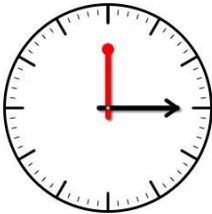
1. Choose a clean, level, spacious assembly area. Avoid hard surfaces that may damage the product
2. Take care when lifting. Product should be assembled as near as possible to the point of use
3. Ensure that you have all required contents for complete assembly
4. Always read the assembly instructions carefully before beginning assembly.
5. Keep all hardware parts and packaging out of reach of small children.
6. Do not over tighten the screws and bolts as this may damage the threads
7. Assembly is to be carried out by a competent adult(s) ONLY
8. During assembly, children should be kept away from the product due to possible risk to injury.
9. Do not use this item if any components are missing or damaged.
10. Please keep the instructions for future reference.

	
Allow 15 min	For 1 person

PARTS LIST

Ax1

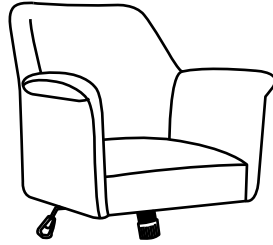

Bx1

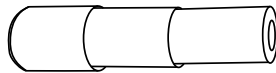

Cx1

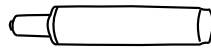

Dx1

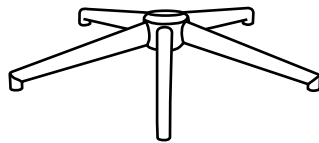

Ex5



SETP 1:

- Prepare a protected surface with a blanket or cardboard.
- Attach the castors(E) to the base(D). As shown below.
- Insert Gas lift(C) into the base(D), press down firmly. Check that the gas lift is properly in, lift the gas lift and make sure the base goes up with it.
- Place the cover(B) over the gas lift(C) and let it slide down.

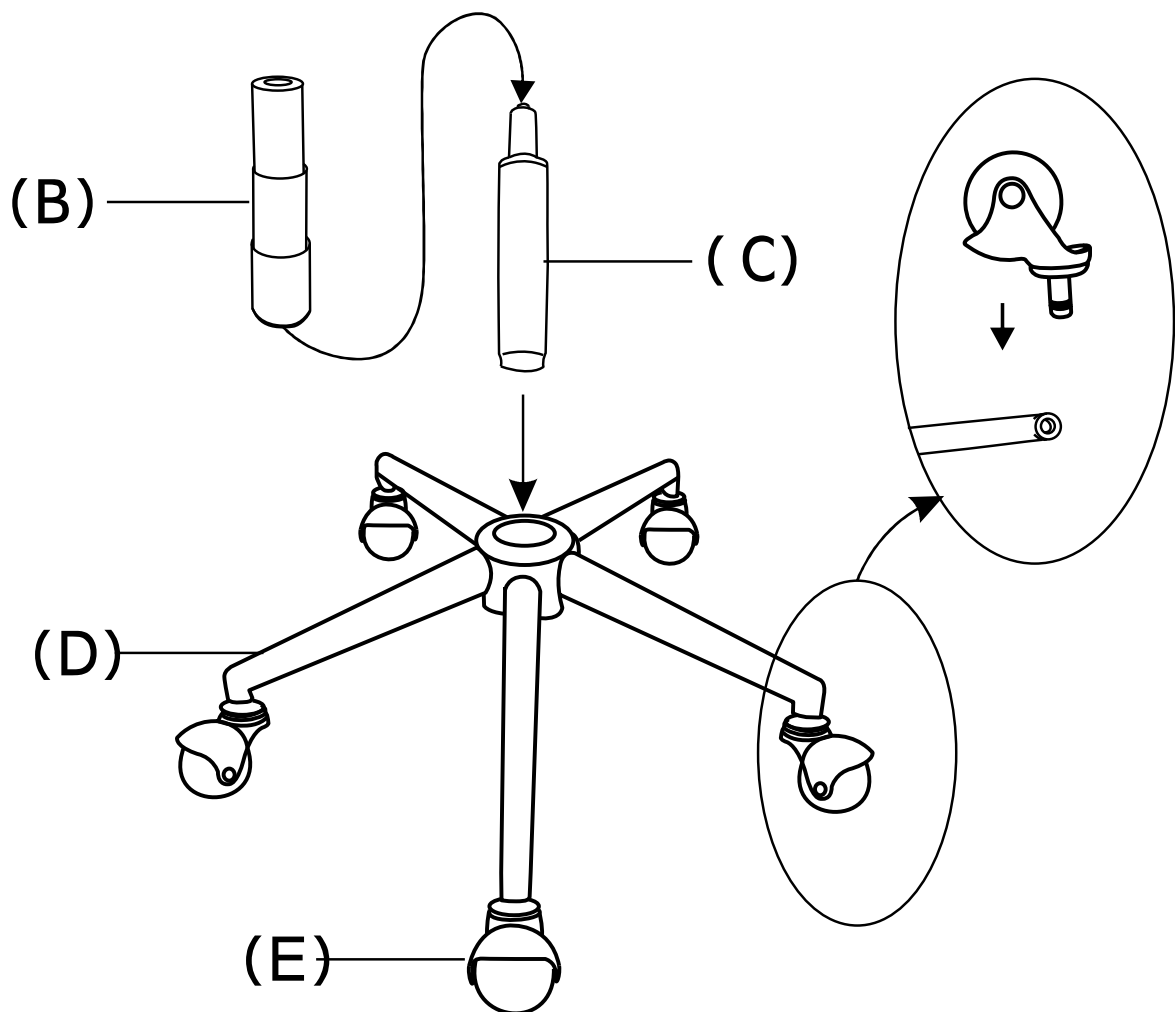

STEP 2:

- Attach the seat(A) to the gas lift, as shown below.
- Press down firmly. Check that the gas lift is properly in, lift the seat and make sure the gas lift goes up with it.

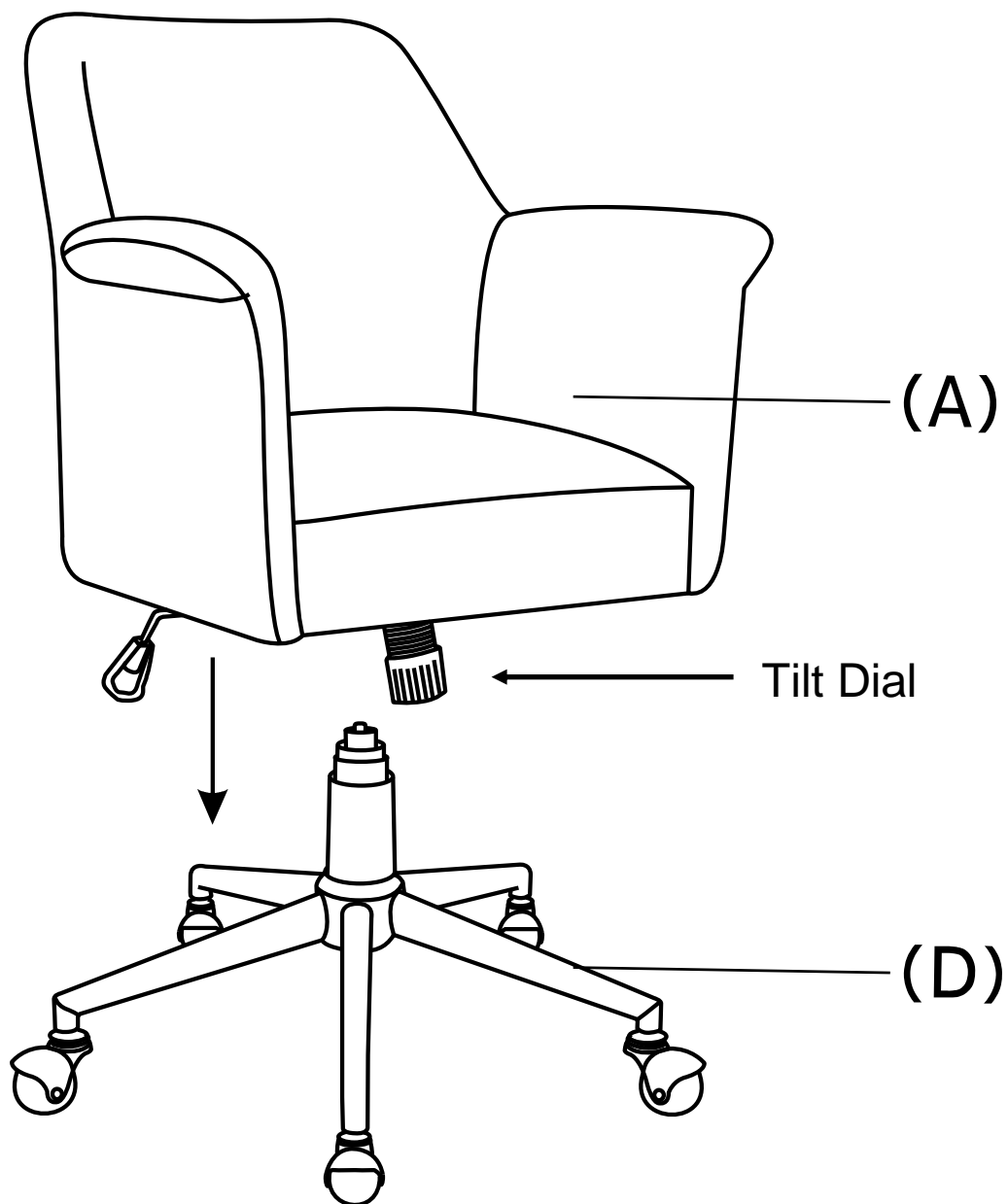

The tilt dial can be adjusted to limit the amount the can tilt.

ASSEMBLY IS COMPLETE

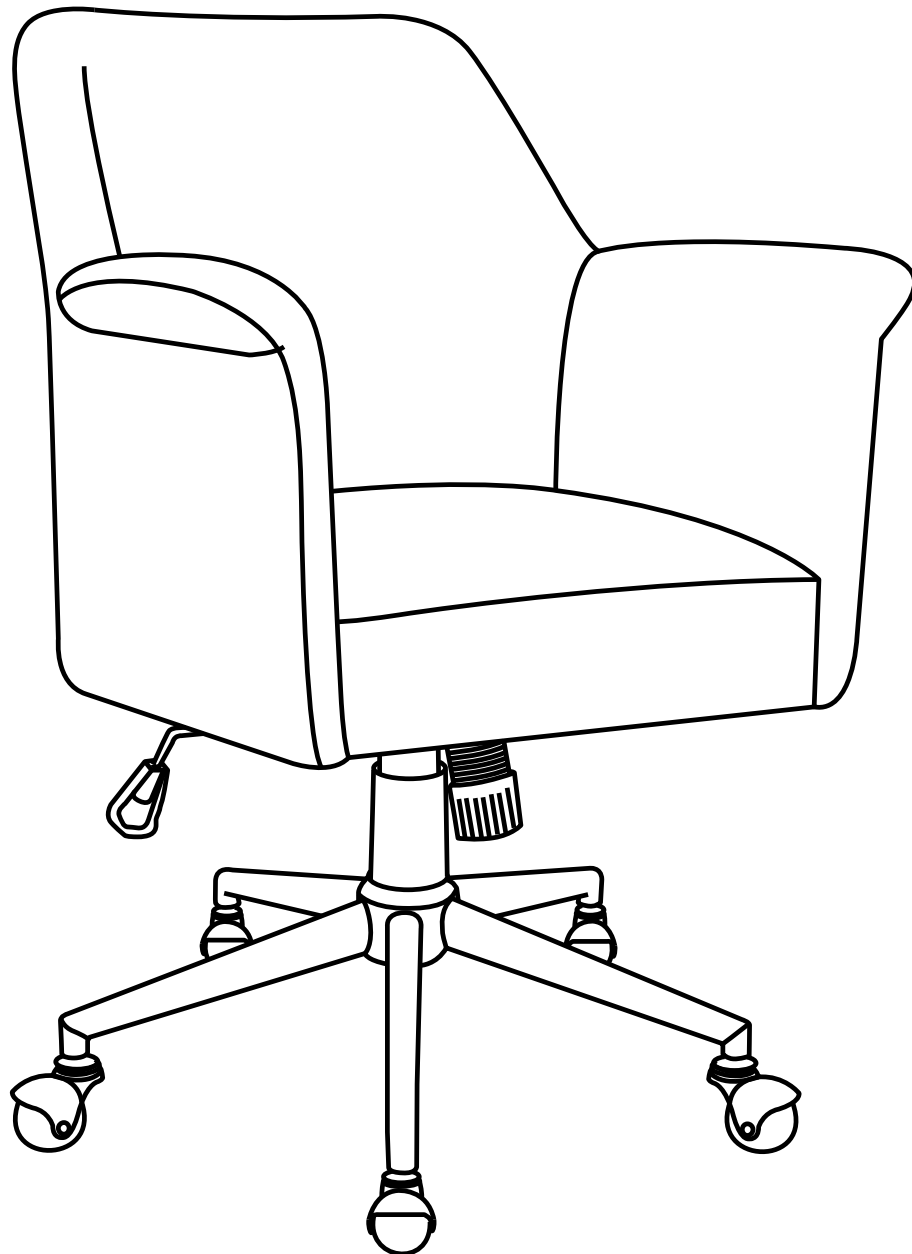

CARE AND MAINTENANCE

OFFICE CHAIR

DO NOT REMOVE THIS LABEL

- DO NOT STAND ON THIS CHAIR-DO NOT USE THIS CHAIR AS STEP LADDER.
- USE THIS PRODUCT ONLY FOR SEATING ONE PERSON AT A TIME.
- DO NOT USE THIS CHAIR UNLESS ALL BOLTS, SCREWS AND KNOBS ARE FIRMLY SECURED.
- AT LEAST EVERY 4 MONTHS, CHECK ALL BOLTS, SCREWS AND KNOBS TO BE SURE THEY ARE TIGHT.
- IF PARTS ARE MISSING, BROKEN, DAMAGED OR WORN, STOP USE THE PRODUCT UNTIL REPAIRS ARE MADE. USING FACTORY AUTHORIZED PARTS.
- FAILURE TO FOLLOW THESE WARNINGS COULD RESULT IN SERIOUS INJURY.